

# **LG-T2727RGBA-TD-A**

## **DATA SHEET**

SPEC.NO. : SZ19081205  
DATE : 2020/05/07  
REV. : A/1

Approved By:

Checked By:

Prepared By:



**LG-T2727RGBA-TD-A**

**TOP Full-color LED**

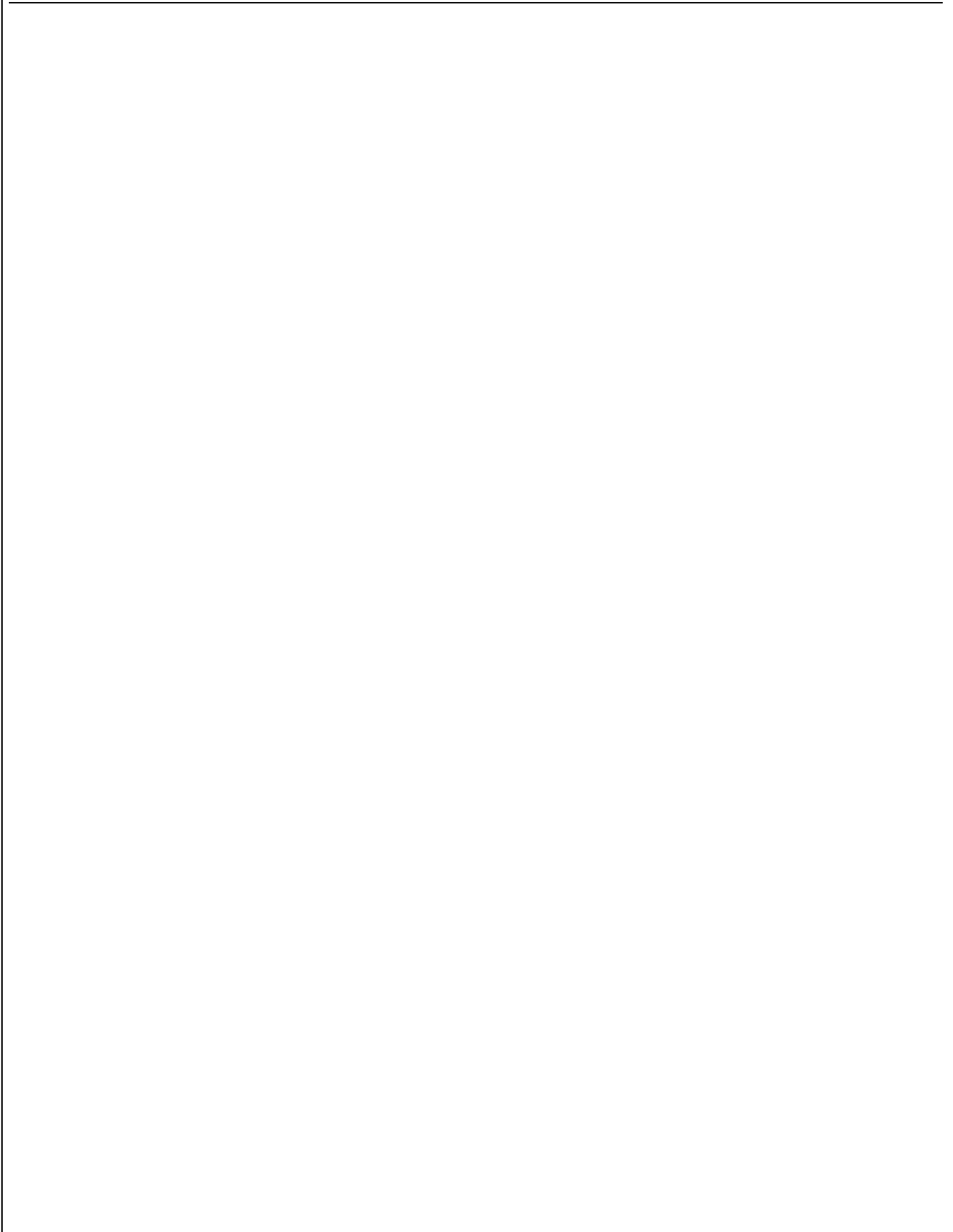

**LIGHT**

**LIGHT ELECTRONICS CO., LTD.**

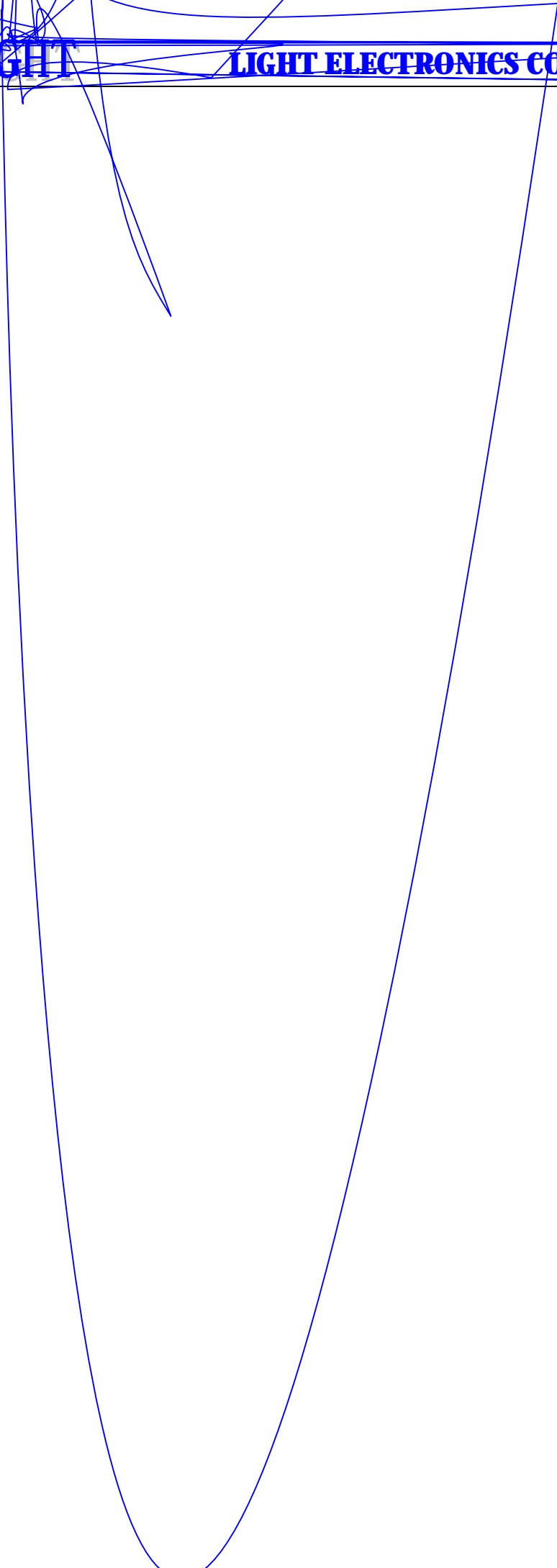

## Typical Characteristics Curves

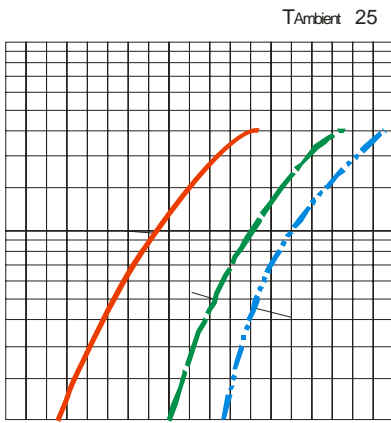

$T_{Ambient} 25$

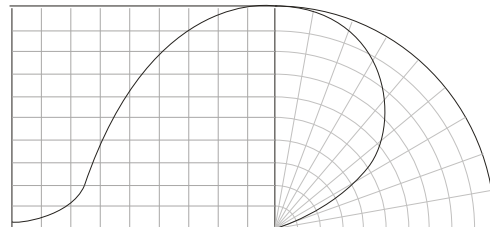
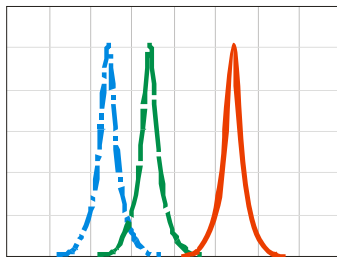
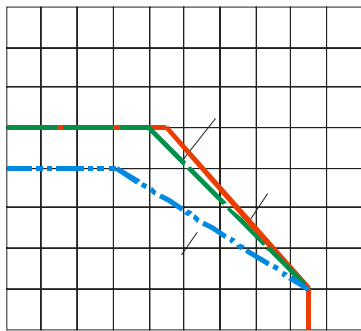



LIG

**LIGHT ELECTRONICS CO., LTD.**

---

## 1

### Packaging (1)

◇ Carrier Tape

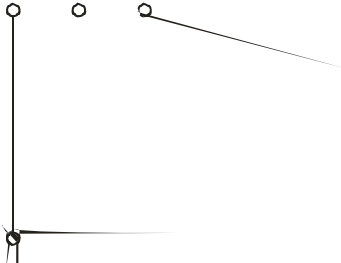

◇ Details Of Carrier Tape

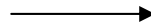

◇ Reel Dimension

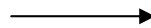

## 2

### Packaging( 2)



#### Moisture Proof and Anti-Electrostatic Foil Bag

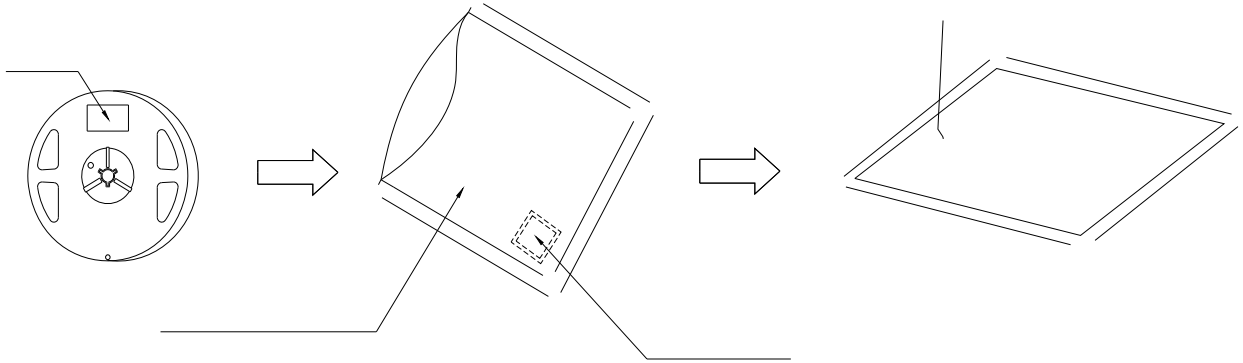

#### Cardboard Box



#### Label Explanation



1

Guideline for Soldering (1)

1.

Hand Soldering

- 
- 
- 
- 

Reflow Soldering:

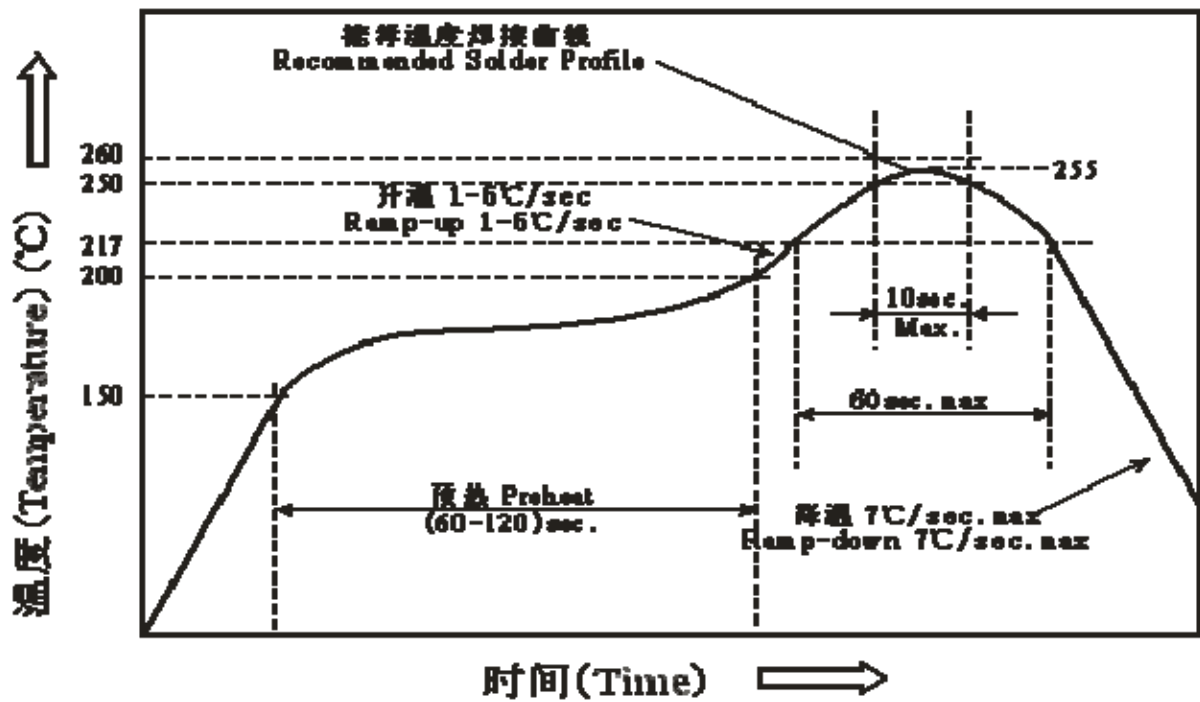

## 2

### Guideline for Soldering (2)



## (1)

### Precautions (1)

1.

#### Storage

- 
- 
- 
- 
- 

2.

#### Static Electricity

- 
- 
-

(2)

### Precautions (2)

3.

#### Design Consideration

•

•

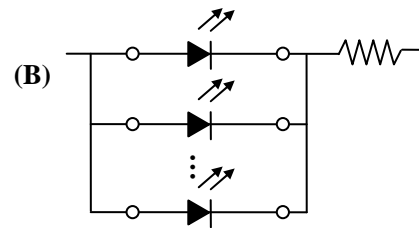
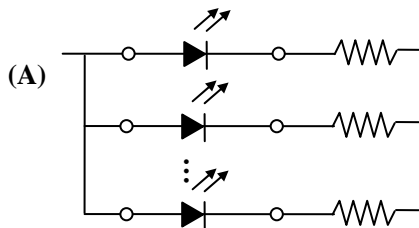

•

4.

#### Reverse voltage protection

•

•

## (3)

### Precautions (3)

5.

The safe temperature for LEDs working

- 

6.

Others

- 

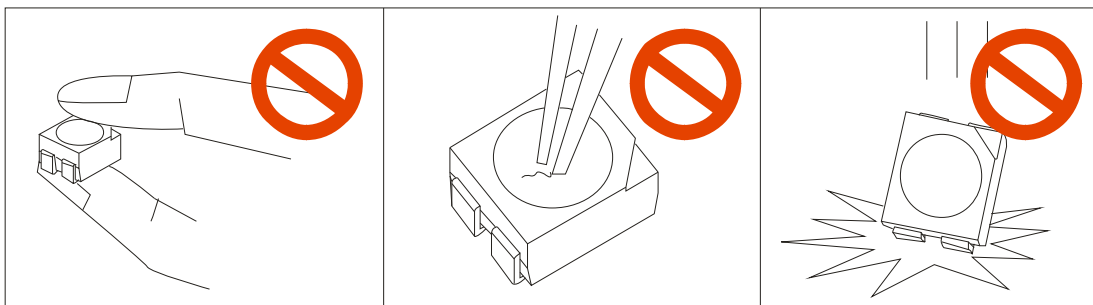

-