

# **SL-T2528RGBIC-L110**

## **DATA SHEET**

SPEC.NO. : SZ18092602  
DATE : 2018/09/26  
REV. : A/0

Approved By:

Checked By:

Prepared By:



% ..... '

& ..... '

' ..... '

( ..... ('

)

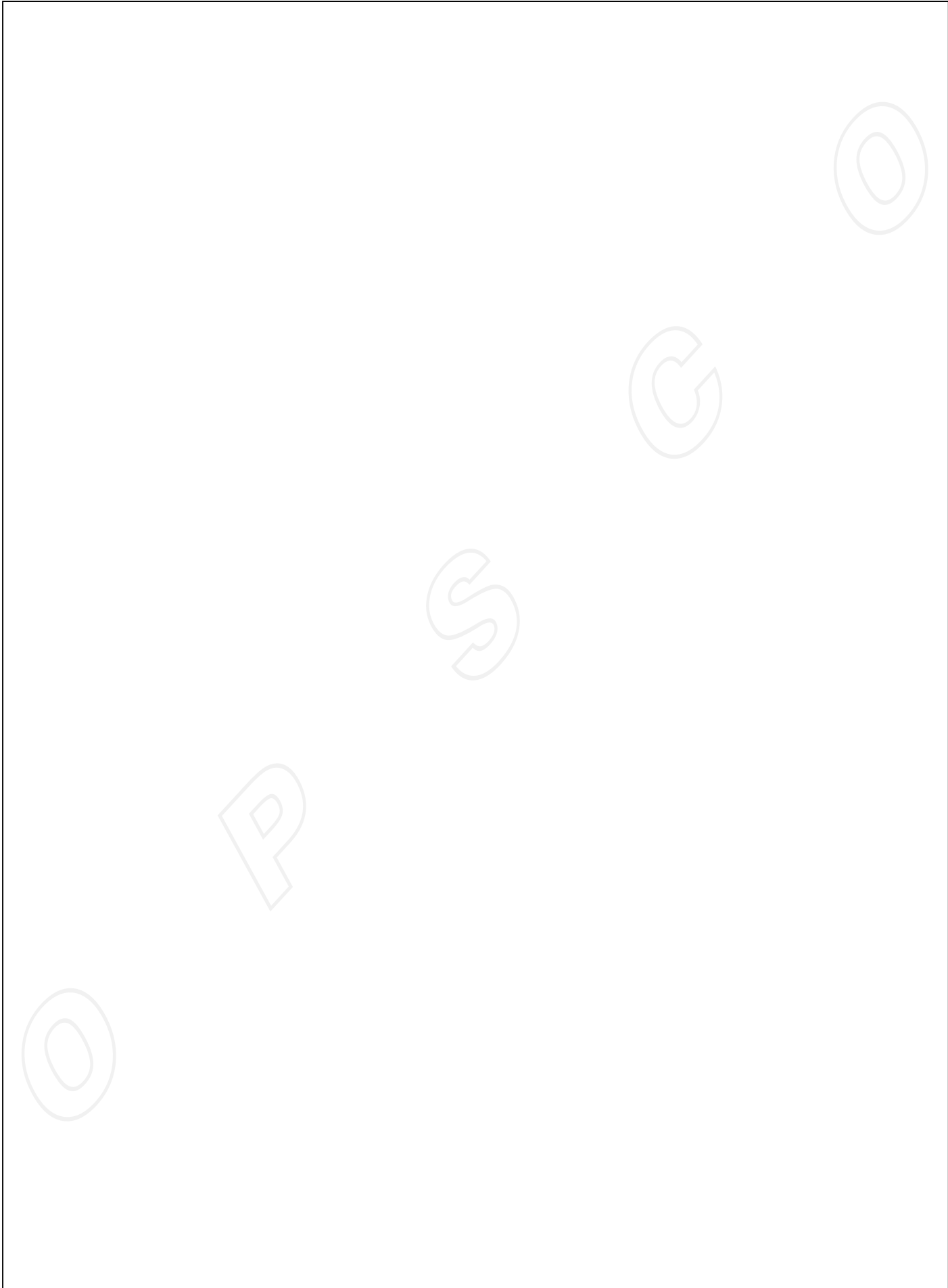



\*" D] b Zi bVh] cb

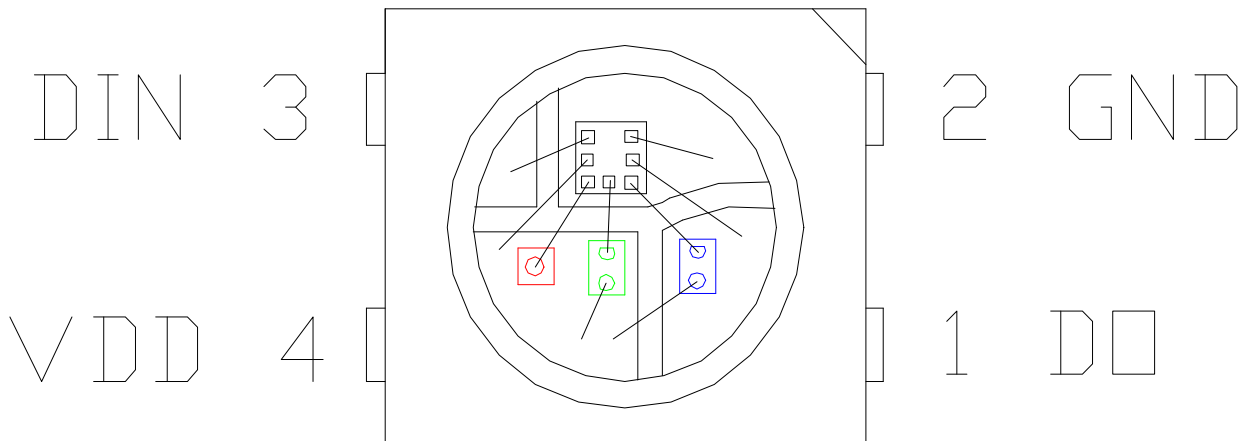

%	8C		
&	; B8		
'	8=B		
(	J88		D76

+ " 9` YVhfc! cdh] WU` VXUFUVhYf] gh] Vg Uh HU1&) F; 6

=hYa	GraVc`	A]I	Hrd	AUI	I b] h	7cbX] h] cbg
8ca] bUbh kUj Y` Yb[ h\`	E` X	; )&\$		)&)	ba	=: 1%&a5
		F *&\$		*&)		
		6 (*)		(+\$		
@ a] bci g ] bhYbg] hm	=J	; , \$\$		%&\$\$	aVK	=: 1%&a5
		F &\$\$		(\$\$		
		6 % \$		' \$\$		

L

**LIGHT ELECTRONICS CO., LTD.**

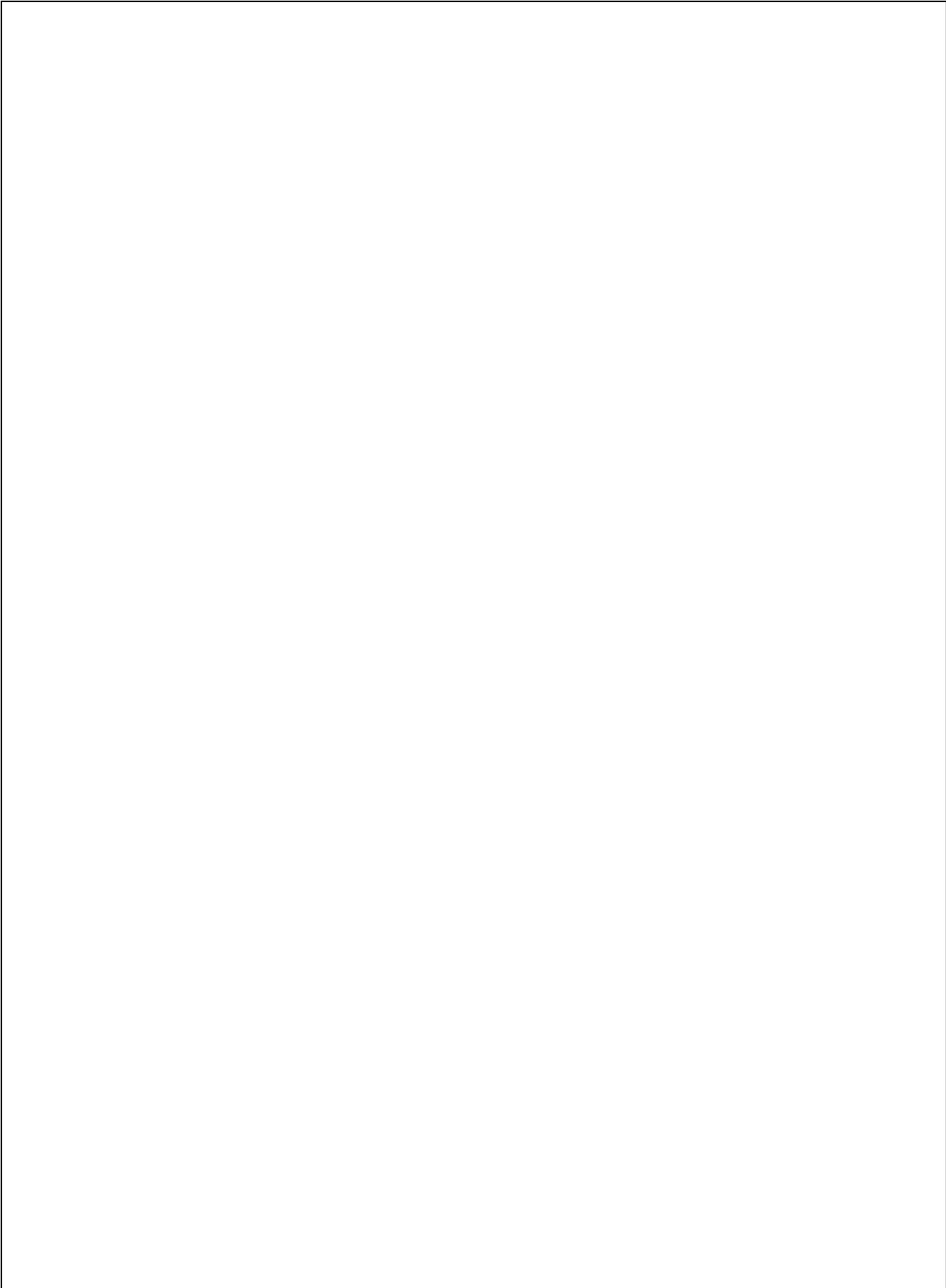

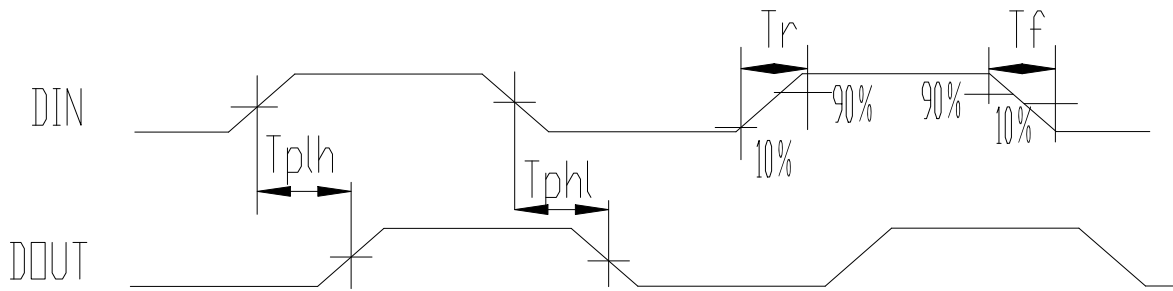

Symbolic representation of the timing diagram above.

Symbolic representation of the timing diagram above					
H	Symbol	Symbol	Symbol	Symbol	Symbol
HC<	\$	&()	&-)	'()	bg
HC@	\$	)()	)-)	*()	bg
H%<	%	)()	)-)	*()	bg
H%@	%	&()	&-)	'()	bg
Hfgh	FYgYh	, \$	!!	!!	i g

Symbolic representation of the timing diagram above.

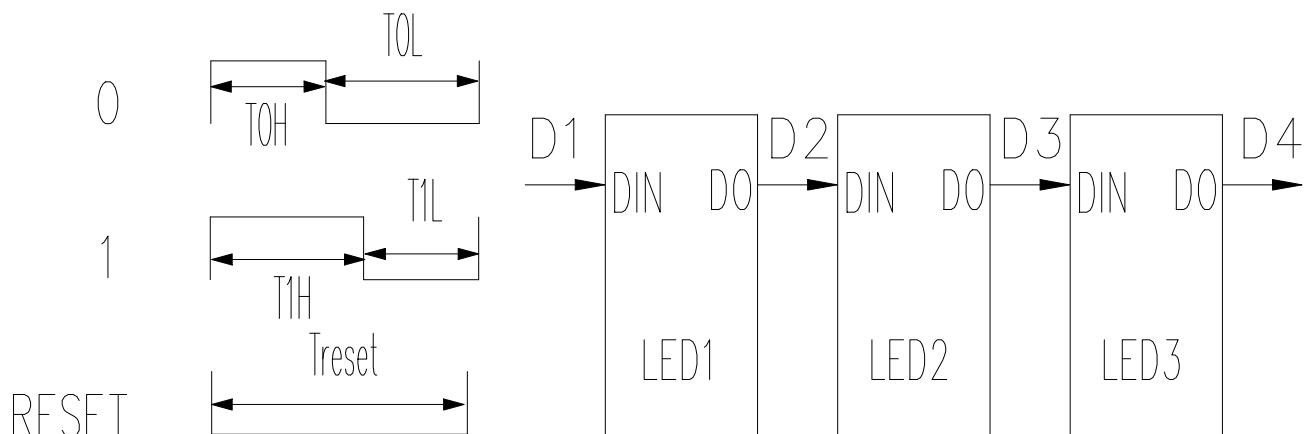

# LIGHT

% " AcXY cZ X

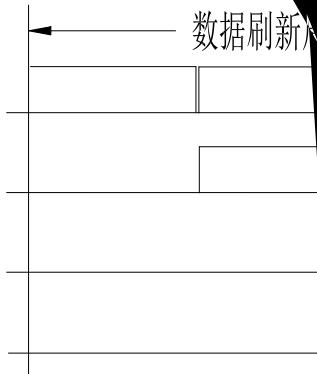



LIG

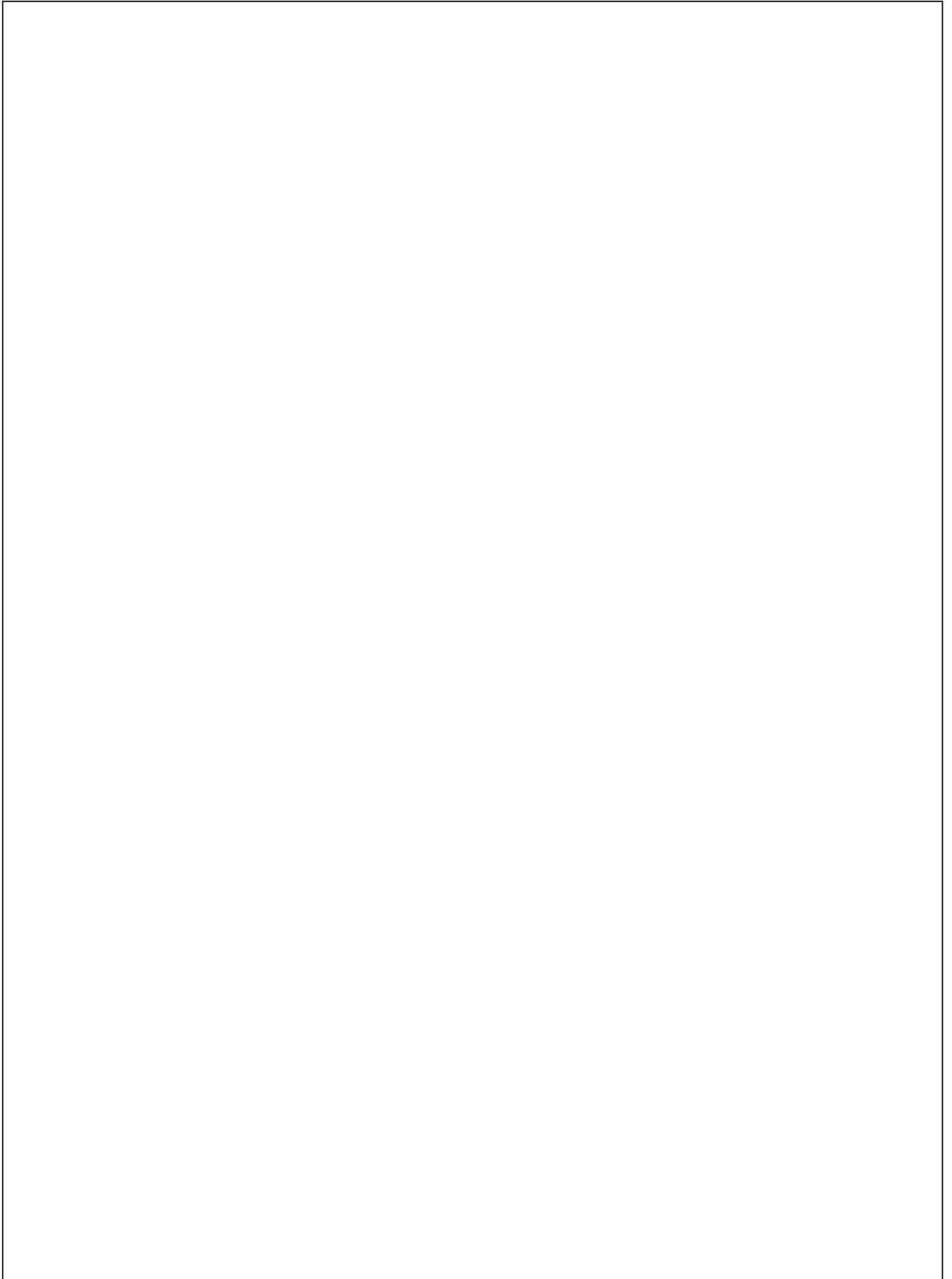

**LIGHT ELECTRONICS CO., LTD.**

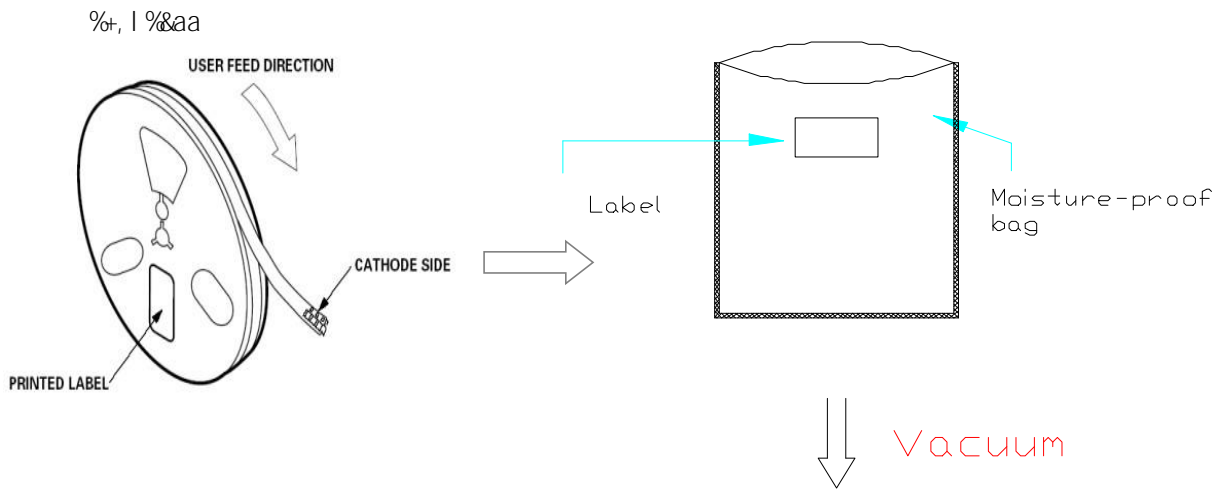
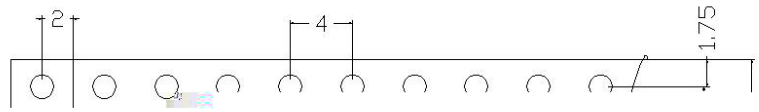

%" DUW\_U[ ] b[ GdYV\ Z] W[h] cbg

: YXX] b[ 8] fYVh] cb



<b>LIGHT</b>	
Light Electronics CO., LTD.	
MODEL NAME: _____	 LOT NO.: _____
QUANTITY: _____	
BIN: _____	
PACKING DATE: _____	
CUSTOMER P/N: _____	

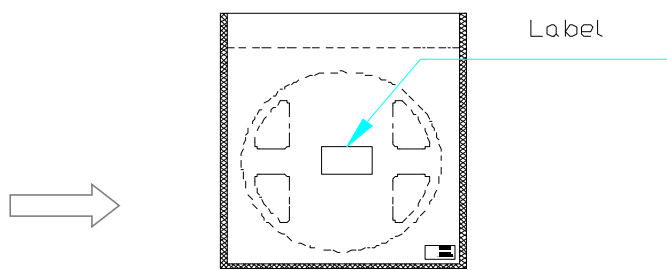

BchY. jc`iaY ]g &\$\$\$dVg/

&\$\$\$dVg

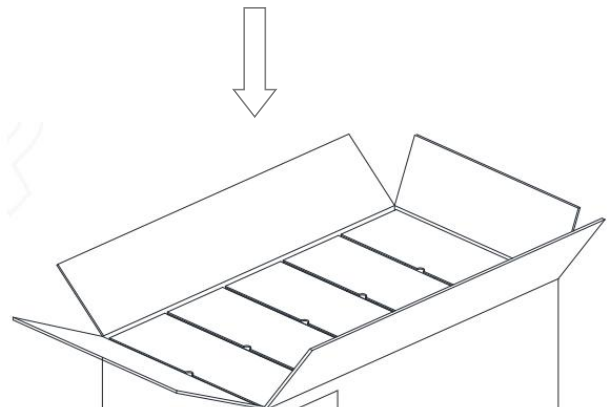

% " FY` ]U]` ]hm

H9GH =H9AG 5B8 F9GI @HG

	HYgh =hYa	FYZ" GhUbXUfX	HYgh 7cbX] h] cbg	BchY	7cbWi g] cb
%	FYZ` ck Gc` XYf] b[	>9G8&&! 6%\$*	Hg` X1&(\$ ž%\$gYW	' h] aYg	\$#&&
&	HYadYfUhi fY 7mWY	>9G8&&! 5%\$(	! &\$ ' \$a] b %&\$ ' \$a] b	&\$ \$ WmWY	\$#&&
,	HYfaU` G\cW_	>9G8&&! 5%\$*	! (\$ %&a] b %&) %&a] b	&\$ \$ WmWY	\$#&&
(	<] [\ HYadYfUhi fY GhcfU[ Y	>9G8&&! 5%\$'	H,1%\$\$	%\$\$\$ \fg	\$#&&
)	@ck HYadYfUhi fY GhcfU[ Y	>9G8&&! 5%%	H,1! (\$	%\$\$\$ \fg	\$#&&
*	DckYf hYadYfUhi fY 7mW] b[	>9G8&&! 5%\$)	Cb) a] b! (\$ 2%&a] b 0%&a] b CZZ) a] b%\$\$ 2%&a] b	&\$ \$ WmWY	\$#&&
+	@]ZY HYgh	>9G8&&! 5%\$,	H,1&) = 1%&a5	%\$\$\$ \fg	\$#&&
,	<] [\ <i a] X] hm <YUh @]ZY HYgh	>9G8&&! 5%\$%	*\$ F<1- \$i = 1%&a5	%\$\$\$ \fg	\$#&&

% " FYZ` ck dfcZ]` Y

GAB FYZ` ck Gc` XYf] b[ =bghfi W] cbg

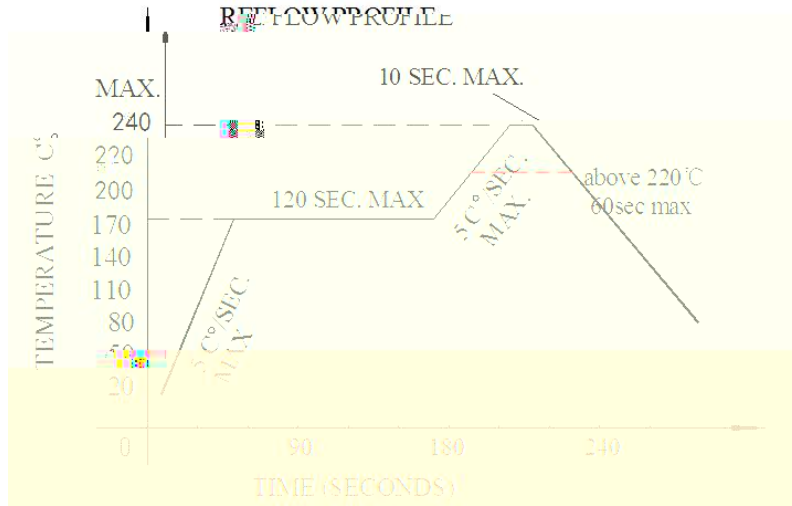

U" FYZ` ck gc` XYf] b[ g\ci` X bch VY XcbY acfY h\Ub hkc h] aYg

&

V" K\Yb gc` XYf] b[ žXc bch di h ghfYgg cb h\Y @98g Xi f] b[ \YUh] b[

@98

Gc` XYf] b[ ] fcb

U" K\Yb \UbX gc` XYf] b[ ž \_YYd h\Y hYadYfUhi fY cZ h\Y ] fcb i bXYf ' \$\$ ž UbX Uh h\Uh

hYadYfUhi fY \_YYd h\Y h] aY i bXYf ' gYW

' \$\$

V" H\Y \UbX gc` XYf] b[ g\ci` X VY XcbY cb` m U h] aY

FYkcf\_

U" 7i ghcaYf ai gh Z] b] g\ fYkcf\_ k] h\] b ) gYWi bXYf & (\$

& (\$ )

V" H\Y \YUX cZ ] fcb WUb bch hci WX h\Y @98g

@98

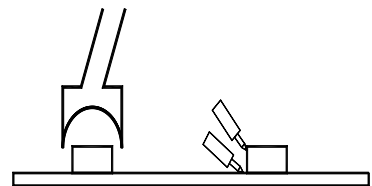

W Hk] b] \YUX hndY ] g dfYZYffYX"



&\$" 75I H=CBG

BchY Zcf i gY

=b cfXYf hc Ybgi fY h\Uh =7 `Uad VYUXg UfY i gYX ]b GAH dUhW\ fYZ` ck kY` X]b[ UbX ]b  
h\Y i gY cZ h\Y dfcWgg m]Y` X UbX ghUV]` ]hmcZ h\Y dfcXi Vhž h\Y Zc` `ck]b[ dfcW\Xi fYg UfY  
gdYW\Z]YX UZhYf aUbm hYghg.

=7 GAH

U GUad` Y Yj U i Uh]cb. 6YW\i gY h\]g dfcXi Vh ]g U Vi ]` h! ]b =7 dfcXi Vhž h\Y cj YfU` `dfcWgg  
]g X]ZZYfYbh Zfca V\bj Ybh]cbU` F; 6 dfcXi Vhž gc h\Y WghcaYf g]XY bYYXg hc W\ffm ci h  
U` ! fci bX j Yf]Z]W\h]cb Xi f]b[ h\Y GUad` Y Yj U i Uh]cb hc Ybgi fY h\Y aUhW\]b[ dYfZcfaUbW  
cZ h\Y dfcXi Vh

=7 F; 6

V =bV\ta]b[ aUhYf]U` ]bgdYVh]cb. Ybgi fY h\Y j UW i a dUW\]b[ ]g ]bhUVh UbX h\YfY ]g bc  
j UW i a `YU\_U[Y" =Z h\YfY ]g j UW i a `YU\_U[Yž d` YUgY V\bz]fa k\Yh\Yf h\Y fYZ` ck kY` X]b[ ]g  
UVbcfaU" =Z ]h ]g UVbcfaU ž d` YUgY fYhi fb hc h\Y ZUVhcfm Zcf \][\! hYadYfUhi fY  
XY\i a]X]Z]W\h]cb"

W I gY. D` YUgY V\bz]fa h\YYV\bzZXbW kVbY



X AU] bhYbUbWV. aUhYf] U` g\ci ` X VY Wcad` YhYX k] h\] b ( \ci fg UbX XcaYgh] WXYaUbX UZhYf  
 fYZ` ck gc` XYf] b[ hYgh UbX fYdU] f h\Y ` Uad VYUXž gi V\ Ug acfY h\Ub ( \ci fg bYYX hc fYdU] f  
 h\Y ` Uad d` UhY hYadYfUhi fY UVcj Y \*) XY\i a] X] Z] WUh] cb %& \ci fg hc fYdU] f kcf\_ž UbX  
 fYdU] f h\Y ` Uad VYUX U` gc ai gh W\ffmcb h\Y ` ck hYadYfUhi fY UVcj Y \*) XY\i a] X] Z] WUh] cb  
 %& \ci fgž i gY dfc\] V] hYX ]b h\Y dfcWVgg cZ aU] bhYbUbWV k] h\ hYadYfUhi fY cj Yf &(\$  
 \YUh] b[ aUW\] bY fYdU] fž dfc\] V] h h\Y k\c` Y d` UhY d` UWVX ]b h\Y \YUh] b[ ghU[Y fYdU] fž  
 Zc` `ck h\Y df] bWVd` Y cZ VUX k\] V\ fYhi fb k\] V\ aYUgi f] b["

( ( \*) %& \*) %& &(\$

Y KUfa dfcadh. h\Y k\c` Y dfcWVgg gdYWVU` Vcbg] XYfUh] cbg Zcf ` ] [\h VYUX VYZcfY i gY  
 j UWVi a dUW\_] b[ž XY\i a] X] Z] WUh] cbž GAH d` UWVaYbh h] aY UbX kcf\_g\cd cZ hYadYfUhi fY UbX  
 \i a] X] hmVcbhfc` ž dfcXi Vh aU] bhYbUbWV ` Uad d` UhY ] Z VUFY Uh fcca hYadYfUhi fY Ybj ] fcbaybh  
 Zcf U` cb[ h] aY bYYX hc XY\i a] X] Z] WUh] cbž ` ] [\h VcUfX UbX ` ] [\h VYUX ` ] [\h VYUXg Ug @98  
 Y` YVhfcb] WdfcXi Vhgž bYYX hc dUm UhhYbh] cb hc ac] ghi fY ] b gdf] b[ UbX gi aaYfž Ui hi ab UbX  
 k] bhYf Ubh] ! ghUh] Vž dfcXi Vh ei U ] hm] g YbhYfdf] gYfig ` ] ZYž hc h\Y ei U ] hmghf] j Yg Zcf h\Y  
 gi fj ] j U ž hc h\Y ei U ] hmghf] j Yg Zcf h\Y XYj Y` cdaYbh ] g ci f Vcbg] ghYbh U] a" 5` gc ] b cfXYf  
 hc Ybgi fY h\Y ei U ] hmcZ h\Y W] Ybhž d` YUgY ghf] Vh` m fYZYf hc h\Y UVcj Y fYVcaYbXUh] cbg

@98

LIGHT

**LIGHT ELECTRONICS CO., LTD.**

